



Technical Description

For the supply of
1 x MTS Vacuum Suction Unit
DINO-3
on chassis MAN TGS 6x4



MTS DINO-3 EQUIPMENT TO BE SUPPLIED MOUNTED ON 3 AXLE CHASSIS WILL CONSIST OF:

Body structure

DINO 3 Container with lid	8 m3	<ul style="list-style-type: none"> • 8mtr³ hydraulically operated side tipping spoil hopper • Height container pivot min. 2m (easy clean tilt in container) • Climb steps to the container with protection points • Cover with wear-resistant rejection system • Several water valves in the hopper • Balanced pay load after loading
Container inner lining	BH - AUS	<ul style="list-style-type: none"> • Lining of tilting panel with stainless steel VA including drip edge 
Water drain valves	H2O EXT	<ul style="list-style-type: none"> • 2 outlets in the core container (blue) 
Inspection hatch	INSPEC	<ul style="list-style-type: none"> • Manually lockable inspection hatch in cover • Climb steps and grab handles on the hopper end and lid 

HIGH SUCTION PERFORMANCE FANS

MTS Twin fans F - 36.000 MEGA	F 36.000
<ul style="list-style-type: none">• European Patent for multistage Fan System in Suction Excavators• MTS F 36.000,00 Twin fans in a row with an air flow volume of up to 36.000 m³/h and• Negative pressure of up to 40.000 Pa.• Fan blade wheels made out of highly abrasion proofed special steel; including coupling,• Turbine power max. 220 kW• FES Fuel economy system decreases fuel consumption by 20 %• Central Lubrication system for fan bearings electronically controlled• Fans can be operated in different performance stages• Fans system driven by robust transfer box• Tooth Belt system with self-spanner• Fast STOP <p>Advantages:</p> <p>MTS uses 900 mm diameter fans to avoid bearings which must be cooled to reach same performance Fans are driven by an intermediate gear which is able to transfer 400 kW.</p> <p>Large number of power levels Extreme suction power</p> <p>Superb cardan shaft angles due to fan system in declination</p> <p>No maintenance intensive NMV-drive, but durable low-maintenance intermediate gear</p>	 <p><i>Kompressor</i></p> <p><i>Turbine 1</i> <i>Turbine 2</i></p>  <p>PICO</p>  

Fans – emergency shutdown	FAST-CUT	
<p>Safety:</p> <ul style="list-style-type: none"> • Fast partitioning of suction to immediately stop the suction flow. They are operated by all emergency stop operations and at shutdown of the operating speed <p>Economy:</p> <ul style="list-style-type: none"> • Apart from the proven MTS - FES Fuel Economy System the foreclosure also reduces the consumption of startup and shutdown of the fans and in the short-cut mode 		

Compressed air system / Air compressor	AIRSYS	
<ul style="list-style-type: none"> • Rotary compressor 10 bar with 4.5m³/min air flow providing oiled and non oiled at the rear of the vehicle • 2 oiled and 2 non oiled air tool connections at the rear of the vehicle • 60 l Buffer air tank • Air spray pistol in machine house • Sufficient performance - even in summer mode <p>Advantages:</p> <p>High air capacity for pneumatic air lance and air tools at high ambient temperatures</p>		

2 pieces hose reel for air hose

- 2 x air hose 10 m 1 "mounted on stainless steel roller with automatic back down on machine frame
- A hose reel connected to oiled air
- A hose reel connected to non-oiled air

Advantage:

Air hoses quickly undressed and cleaned up safely



MTS Material Deposition System (patented)

ZYKL

- 3 stage patented MTS high-performance filter system, based cyclone, with electronically controlled cleaning after vacuuming (pulse-jet technology)
- 98% of physical deposition of material sucked
- 174 m² fine filter area in the 3rd Filter stage, waterproof polyester filter
- Filter chamber emptied automatically tilting the container
- Excellent load distribution arrangement in the rear of the vehicle

Benefits of the patented filter system:

By this material deposition system we ensure higher performance between 20% and 30% suction at same drive power.

No cleaning required

Low loading of the dust filter by physical effective cyclone separation, thereby longest service life of the filter and constant suction power even when vacuuming wet and moist materials.

Automatic cleaning during and after the suction process is possible.

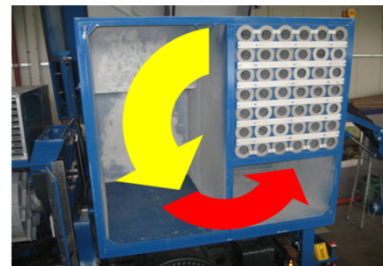

MODUL : MEGA BOOM WIDE RANGE

Hydraulic MEGA ARM - Extra-large suction area - LATEST VERSION WITH OVER EXTENSION of the end joint

MEGA ARM

Surcharge to the POWER ARM
€ 6.000,00

- Hydraulic MEGA ARM – extreme reach –
- MTS MEGA ARM for longest range and increased power application
- Extreme long and stable arm
- 6 bends with enormous reach
- 8 m hose length, hose diameter 25 cm
- 180 ° to be swiveled

- **Range extension with more than 10 m**

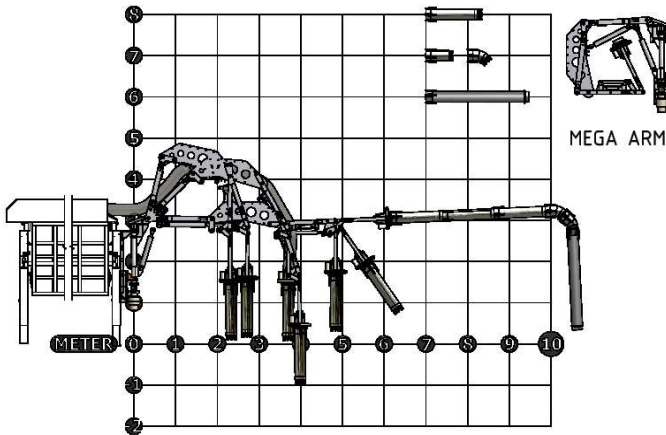

Advantages:

- Virtually maintenance-free power arm
- Welded bolt construction
- Equipped with long-life maintenance-free bushings

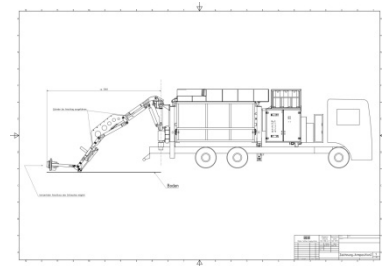

TOP Suction Hose mounted on boom

TOP

- Suction hose high resistant lengths 7 m/7,9m
- High abrasion protection



IKE – Turnable Suction Tube

IKE

- Hydraulic rotary device for suction pipe
- Forward and reverse on the remote control
- Following the on-board hydraulics or external hydraulic connection
- Rotating suction adapter
- Tubing on power arm
- Length: 1.3 m Diameter: 250 mm

Advantages:

IKE from MTS sets the NEW STANDARD in being 50 % faster than other operators not using IKE to make Foundations or loose compact soil



MODEL: SUCTIONING & DRIVING & STEERING

Hydrostatic drive system with steering and warning sensors

- Hydrostatic drive for the truck base for sucking while driving or change the working position of the truck with the radio remote control
- Speed adjustable, max forward and reverse. 6 kmh
- Operation via remote control
- Incline / decline of up to 6%
- Remote steering of the vehicle with the joystick
- Warning system with sensors on the driver's cabin (inactivate)
- Supports automatic: Automatic stopping and starting up the posts in hydrostatic operation without additional switch on the remote control (inactivate)

MTS uses OMSI transfer boxes with integrated Hydrostatic gears. A major advantage is the use at an incline and decline situation



Storage Boxes

TOOL 2-fach

STANDARD

- Passenger side mounted tool boxes, lined with rubber mats and gas springs, lockable
- DINO 3/5 big sized storage boxes to store accessories and tools

Advantages:

Tool boxes on the passenger side, the operator prevent accidents during transport and work. Shortest distance from the tool to work. Equal loading of the suction unit from right to left, thus safer driving on curved roads.





Hydraulic supports	STÜ - 3-fach	
<ul style="list-style-type: none"> • 3 hydraulic supports for the stabilization and relief of the chassis when emptying the container and during the suction process <p>Advantages:</p> <p>When vacuuming the vehicle is stable, even in safe working with air-suspended vehicles</p>		

100 l Water System pressurized	H2O -100	
<ul style="list-style-type: none"> • 100 l Water tank (max. 6 bar) • Water level gauge • 10 m water hose 3/4" with quick couplings • Connection provided at rear of the vehicle • (Optional up to 1000 l or as high pressure system) 		

Vehicle Operations



Controls	CONTROL	
<p>In the drivers cabin:</p> <ul style="list-style-type: none"> • Main switch • Rotating lights on / off • PTOs / intermediate gear on / off • Immobilizer with drained stability props • Hydrostatic on/ off <p>Radio Remote Control:</p> <ul style="list-style-type: none"> • Proportional functions for all Suction and Tipping operations • German manufacturer GROSS with following functions: <ul style="list-style-type: none"> ○ Boom operation ○ Tipping operation ○ Compressor ON/OFF ○ Filter Cleaning- System ON/OFF ○ Switch Boom/ Tipping operation ○ Emergency shutdown / Motor Start/Stop/Reset ○ 3 stages off on speed • Storage battery and battery charging set, installed in the cab • Umbilical console with cable, length 10 m; alternative second sender <p>Control panel with additional functions:</p> <ul style="list-style-type: none"> • Air compressor on/off • Fans on/off • Working lights on/off • Diagnostic monitor • Filter cleaning on/off • Two speed indicators for fan and compressor, <p>Electrical Controls:</p> <ul style="list-style-type: none"> • Electrical Control with SPC / PLC technology • Remote diagnostics of the entire controller to quickly locate faults • In addition, error display with plain text display for solution • Integrated SIM card and unlimited time Stabilizing supports – Automatic <p>Advantages:</p> <p>Remote diagnosis over the phone, text display resolution to the error, lowest cost service after warranty</p>		   <p style="text-align: center;">SPS Ausführung</p>  

<p>Rear of the vehicle</p> <ul style="list-style-type: none"> • Flashing lights on the back of the container • Two 24 V power sockets on the rear of the vehicle to operate additional mobile headlights • Optical light tower display current machine states (eg suction ON, filter control ON, ON HST) 	
--	--

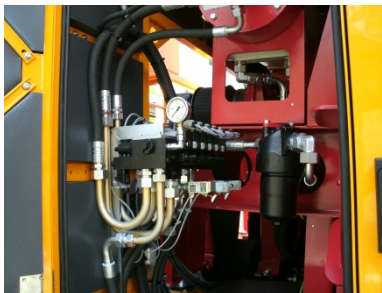
<p>Air exhaust sound silencer / Noise reduction/Air out let</p>	<p>INSU</p>	
<ul style="list-style-type: none"> • Noise reduction due to resonators • Acoustic Isolation of the machine house with high performance anti-noise foam plates • Air out let on top or sideward <p>Advantages:</p> <ul style="list-style-type: none"> ➤ Quiet vehicle, despite high suction ➤ Exhaust outlet on top reduces airflow noise and protects against damage from hot exhaust air near buildings 		 

<p>Dual-circuit hydraulic system</p>	<p>2 HYSYS</p>	
<ul style="list-style-type: none"> • 2 circuits for interference-free operation of air compressor and boom • NTZ bypass fine filter / Additional return filter for hydraulic oil filter with replaceable cartridge (thereby extending the oil change interval to 4-fold) is installed in the hydraulic tank • Filled with hydraulic oil HLP 46 • Hydraulic tank with temperature sensor and level indicator, black powder coated 		

Safety/Security

Safety Package I	S I	<ul style="list-style-type: none">Emergency Shut-Off Functions 
Safety Package II	S II	<ul style="list-style-type: none">Fire extinguisher 6 kg outside 
Safety Package IIIa	S III	<ul style="list-style-type: none">Rear view camera with external microphone and 7"LCD monitor in the cab 

Grounding Reel with terminal and earthing screw spike	GROUND	
<ul style="list-style-type: none"> • Grounding reel with 10 m ground cable and clamp • Connecting conductive parts on the carrier vehicle and suction unit • Earthing screw skewer with wood handle for screwing into the ground for optimum ground contact of the vehicle to the ground 		

Working field light LED	AFB 1-LED	
<ul style="list-style-type: none"> • Working LED Spotlight swivel and tilt at the rear of the vehicle • Two 24 V power sockets on the rear of the vehicle to operate additional mobile concrete headlights 		

Suction accessories and releasing tools

Suction tube	ST 25	
<ul style="list-style-type: none"> • suction pipe D = 250 mm, length 1.3 m reinforced • Galvanized with MTS clamp SYSTEM 2010 • iron crown 		

Suction tube reduction	ST 25 - 13	
<ul style="list-style-type: none"> • suction tube reduction of D = 25 cm to 13 cm, length 1.32 m • Galvanized with MTS clamp SYSTEM 2010 		



Suction hose extension	SSV 2,2 m	
<ul style="list-style-type: none"> • 2.2 m vacuum hose extension with both sides plastic - coupling elements • Fits on MTS Clamp-SYSTEM 2010 		



Suction tube carrier basket (double version shown)		
<ul style="list-style-type: none"> • suction tube extension basket, galvanized, to open on one side, • to store and transport the suction tube or suction hose • Open along both sides when compressed air hose reels are not mounted • Length 1.8 m 		

Transport Rack EASY for suction tubes	Regal	Surcharge € 2.200,00
<ul style="list-style-type: none"> • Transport Rack painted steel frame for tube or hose mounted behind the cab above the frame (3-fold) 		

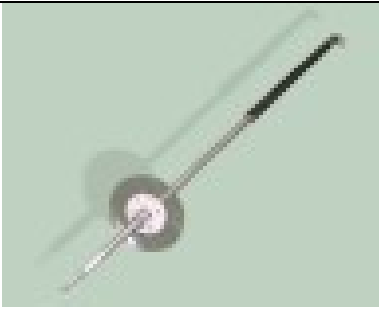
Pneumatic Tools

MTS SET release tools	AIR TOOL SET	
<p>Spade hammer 10 kg</p> <ul style="list-style-type: none"> • Pneumatic mining Spade Hammer (10 kg) with spade and chisels • Optional: 20 kg instead of 10 kg hammer as supplement: EUR 450.00 <p>MTS-air lance</p>		

<ul style="list-style-type: none"> • 2m long, with splash guard and quick release <p>Air hoses</p> <ul style="list-style-type: none"> • Hose for compressed air 2 x 10m d = 19 mm with heavy safety equipment <p>Frame holder for pneumatic tools</p> <ul style="list-style-type: none"> • at the rear of the vehicle, for the insertion of spreader splendor spade hammer, etc. during the process of the suction excavator, powder coated and supplied loose. 	 
--	---

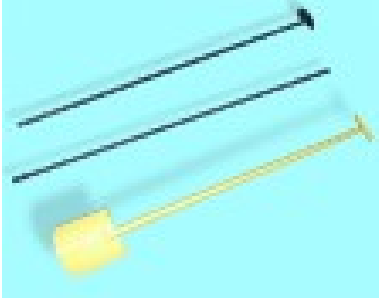
MTS air spade 80 cm	LSPA 80	
<ul style="list-style-type: none"> • MTS pneumatic spade shaft length 80 cm with sturdy spade blade, 7.5 m air hose • (Optional with pointed and flat chisels) 		
ToolSet	TOOL SET	
<ul style="list-style-type: none"> • Professionally equipped toolbox for maintenance and minor repairs • pipe scratches • spade • crowbar • rubber mallet • grease Gun • Spare parts for electrical components 		 

Paintwork	PAINT	
<ul style="list-style-type: none"> • Parts sand blasted before priming • Zinc dust primer • Application of a multi-layer 2K paint • RAL color (metallic and clear coat finish surcharge) • Execution by specialist 		

Aluminum Tread Plates	Cover	STANDARD
<ul style="list-style-type: none"> • Aluminum Tread plates as covers on the sub frame underneath the tank. 		

MACHINERY MANUFACTURE

All MTS Machines are constructed according the new 2006/42 / EG directive (Former 98/37/EC)

Labeling	BESCHR	
<ul style="list-style-type: none"> • All controls, warning and safety information and important service related technical components are symbolized or labeled in the local language. 		